

LAB FILTRATION SYSTEMS & EQUIPMENTS



MARKET SEGMENT

PHARMACEUTICAL & BIOTECHNOLOGY	FOOD & BEVERAGES
CHEMICAL	MINERAL OIL
COLOUR & COATING	HEALTHCARE



CONSTANT FLOW KIT

CONSTANT FLOW KIT can assist in determining the appropriate filtration system for a specific application at constant flow. The constant flow kit requires only an electrical power source for the pump & 3-4 feet of bench space.

MICROFILT Constant Flow Kit consists of

1. Appropriate pump with accessories
2. Flat sheet holder for depth as well as Surface filters. Customized holders also can hold filter cakes
3. Required Instruments / valves etc.



ORDERING GUIDE:

FAMILY	PUMP	TYPE STAGE 1	TYPE STAGE 2	WETTED PART	BASE CONFIGURATION	JACKETING
B0004 = CONSTANT FLOW KIT	A = Paristatic O = Others	A= Cartridge B= Filter Holder C= Bag Filter Housing F= Nutsche Filter	A= Cartridge B= Filter Holder C= Bag Filter Housing F= Nutsche Filter	A = SS316L B = SS316 C = SS304 D = PP E = PVDF F = HALAR G = ETFE H = Hastelloy I = PFA J = PTFE/TEFLON	C = Triclover Clamp N = Nut Bolt R = Rothmann Clamp S = Swing Bolt	J = Jacketed JI = Jacketed & Insulated N = Non Jacketed

CONSTANT PRESSURE KIT

CONSTANT PRESSURE KIT can assist in determining the appropriate filtration system for a specific application at constant pressure. The Constant Pressure Kit requires only an electrical power source for the compressor & 3-4 feet of bench space.

MICROFILT Constant Pressure Kit consists of

1. Appropriate volume pressure vessel with accessories
2. Flat sheet holder for depth as well as Surface filters. Customized holders also can hold filter cakes
3. Required Instruments / valves etc.



ORDERING GUIDE:

FAMILY	PRESSURE VESSEL CAPACITY IN LITRE	TYPE STAGE 1	TYPE STAGE 2	WETTED PART	BASE CONFIGURATION	JACKETING
B0005 = CONSTANT PRESSURE KIT	001=1 002=2 005=5 010=10 020=20 025=25	A= Cartridge B= Filter Holder C= Bag Filter Housing F= Nutsche Filter	A= Cartridge B= Filter Holder C= Bag Filter Housing F= Nutsche Filter	A = SS316L B = SS316 C = SS304 D = PP E = PVDF F = HALAR G = ETFE H = Hastelloy I = PFA J = PTFE/TEFLON	C = Triclover Clamp N = Nut Bolt R = Rothmann Clamp S = Swing Bolt	J = Jacketed JI = Jacketed & Insulated N = Non Jacketed

SDI KIT

MICROFILT provide a **SDI test kit** is to assess the extent of suspended particulate (solids and colloidal) contamination in water or can be applied to process solution also. A **SLIT DENSITY INDEX (SDI)**, also known as Fouling Index. Although most systems have some pre-treatment or other, fine particles are responsible for the fouling of reverse osmosis membranes. In order to measure the degree of this fouling problem, a concept called Silt Density Index is used. High Index waters are measure of dirty, and contaminated. Low index waters are clean and indicate suitability for the fine filtration or R.O. process.



MICROFILT Constant Flow Kit consists of

- Flow control kit .
- Pack of 25 membrane
- Required Instruments, valves etc.

ORDERING GUIDE:

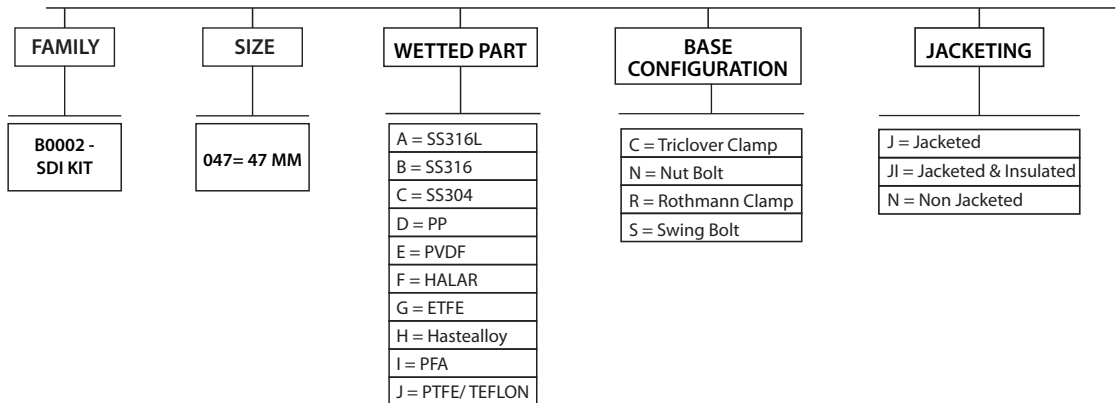

FILTER HOLDER

MICROFILT FILTER HOLDER is provided for the sanitary/non-sanitary filtration application in various industry. This is made up of SS 316 or customized design. We provide Filter Holder which can be completely disassembled so as to clean easily. Our Filter Holder allow you to seal the filter media by hand with tightening and locking wing nuts.



- Filter holder is completely disassembled which is easy for cleaning
- Can be us for filtering small batches of liquid.
- Compact, user friendly & ideal for clean rooms

ORDERING GUIDE:

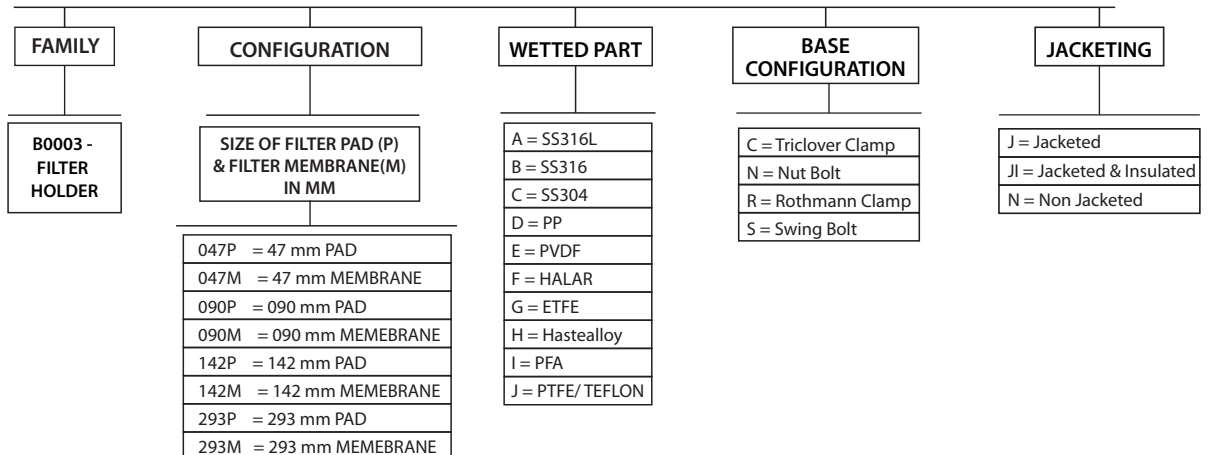

PRESSURE VESSELS

MICROFILT Pressure Vessels are available with varying sizes. It used for holding sterile / non-sterile liquids. Ideal accessories for filtration of small size batches.

- Standard various capacities are available 1, 2, 3, 5, 10, 15, 10, 25, 40, 50, 75, 100, 200, 260 (litres)
- Customize capacities also available, user friendly & ideal for clean rooms



ORDERING GUIDE:

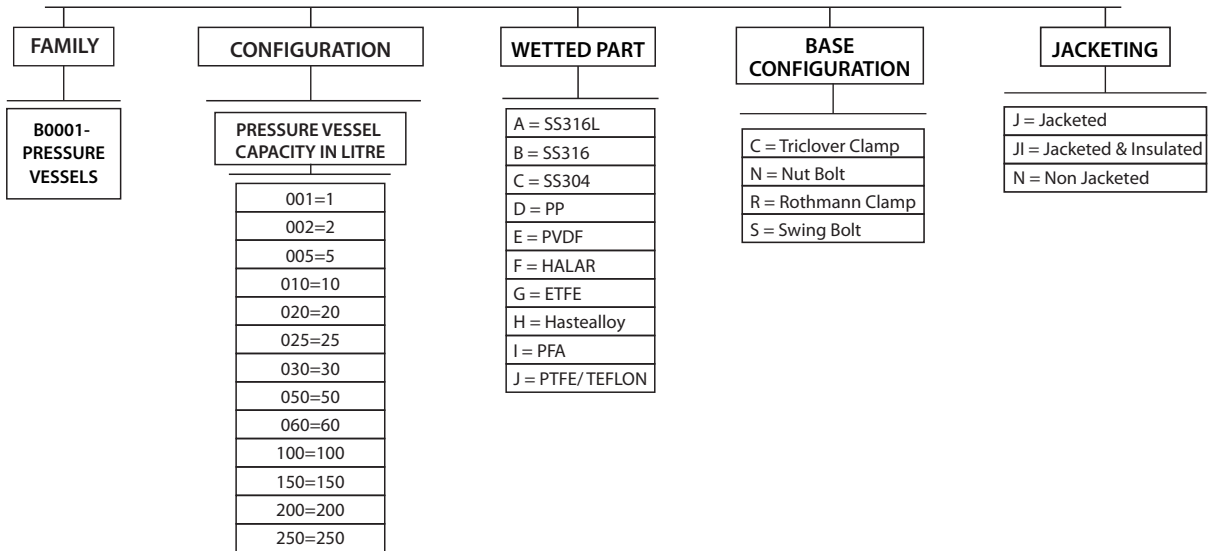

BENCH TOP MAS (MICROFILT AUTOMATED STRAINER)

Bench scale kit of MAS 207 is available which is most useful for laboratory practices. Microfilt Automated Strainer (MAS) are offered in several configurations requiring filtration from more than 1000 microns to less than 20 for liquids very high in viscosity in excess of 1 lac cp. MAS is a self cleanable strainer filter. Various MAS model are also available.

- Eliminates the need for disposable media for many applications
- Mechanically cleaned in place filter, easy CIP
- Choice of various metal cleanable media



ORDERING GUIDE:

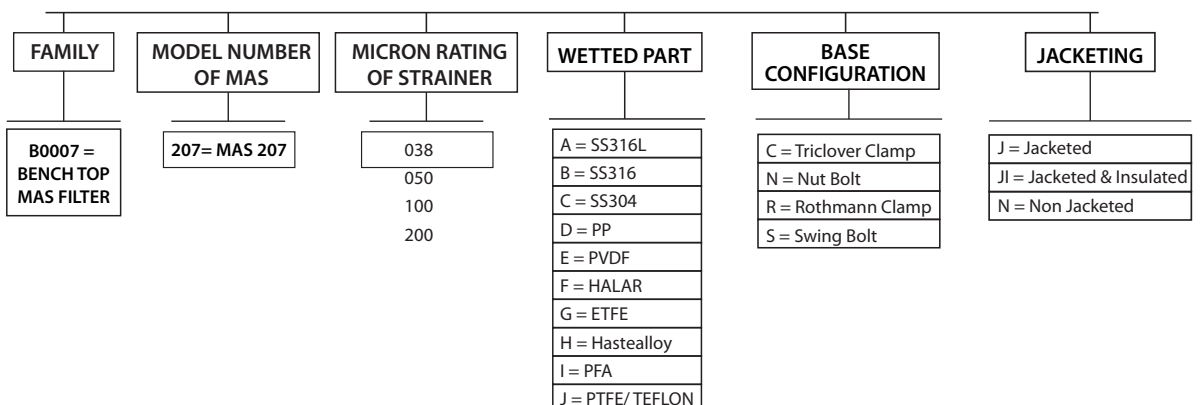

BENCH TOP CROSS FLOW FILTRATION KIT

BENCH TOP CROSS FLOW FILTRATION KIT consists of microfiltration, ultrafiltration & nanofiltration and combination. Designed to suit the critical requirement of industry specific application ranging from Biotech system to effluent treatment for zero discharge. We offer ceramic and polymeric membranes and varying molecular cut-offs rating depends on application.

- Useful for laboratory scale and pilot scale application.
- Easy to installation
- Easy scalable



ORDERING GUIDE:

Family	Membrane Type	Type of Cross flow	MOC of Membrane	No. of Housings	Membranes per Housing	Nominal Diameter of Membrane (inch)	Nominal Length of Membrane (inch)	Design	Level of Automation
B 0006 - CROSS FLOW KIT	C = Ceramic S = Spiral H = Hollow Fiber K = Casset	U = UF M = MF N = NF R = RO	C = Ceramic P = Polyether Sulphone N = PolyAmide F = PolyVinylidene Fluoride	01	01 03 07 19 37 55 99 187	01 02 04	12 23 25	S = Sanitary I = Industrial	A = Fully Automati SA = Semi-automati M = Manual

BENCH TOP NUTSCHE FILTER

Laboratory **NUTSCHE** filter, which is useful for various trial practices in laboratory & pilot scale. NUTSCHE filter batch filtration technique that uses vacuum / pressure in a closed vessel this is mostly used in chemical and pharmaceuticals industries. The system consists of closed filter vessels with filtration media. In this filter, filtration solid/liquid slurry aided by pressurizing the vessels /applying the vacuum.

1. Easy to handle / operation
2. Easy product / cake can be recovered cleanly
3. CIP / SIP is possible
4. Useful for laboratory & pilot scale practices



ORDERING GUIDE:

FAMILY	DIAMETER OF NUTSCHE FILTER	FILTER MEDIA	WETTED PART	BASE CONFIGURATION	JACKETING
B0008 = BENCH TOP NUTSCH FILTER	090= 90 mm 142= 142mm 293= 293mm	P= CMDF Pad C= Cloth S= SS Screen	A = SS316L B = SS316 C = SS304 D = PP E = PVDF F = HALAR G = ETFE H = Hastelloy I = PFA J = PTFE/ TEFLON	C = Triclover Clamp N = Nut Bolt R = Rothmann Clamp S = Swing Bolt	J = Jacketed JI = Jacketed & Insulated N = Non Jacketed

BENCH TOP CANDLE FILTER - CATRECO™

MICROFILT provide Laboratory CATRECO™ as solid/liquid separation kit especially for laboratory bench scale operation. CATRECO™ is a MICROFILT system specifically designed to cater to filtration needs of organic process industries manufacturing fine chemicals, bulk drugs, drug intermediates, agrochemicals, dyes intermediates etc. CATRECO™ is bulk solid Recovery/removal System. Specific to recovery of catalysts for Hydrogenation which recycles the expensive catalysts used in the reaction.

- Minimum hold up
- Enclosed system with compact design
- Backwash cycle



ORDERING GUIDE:

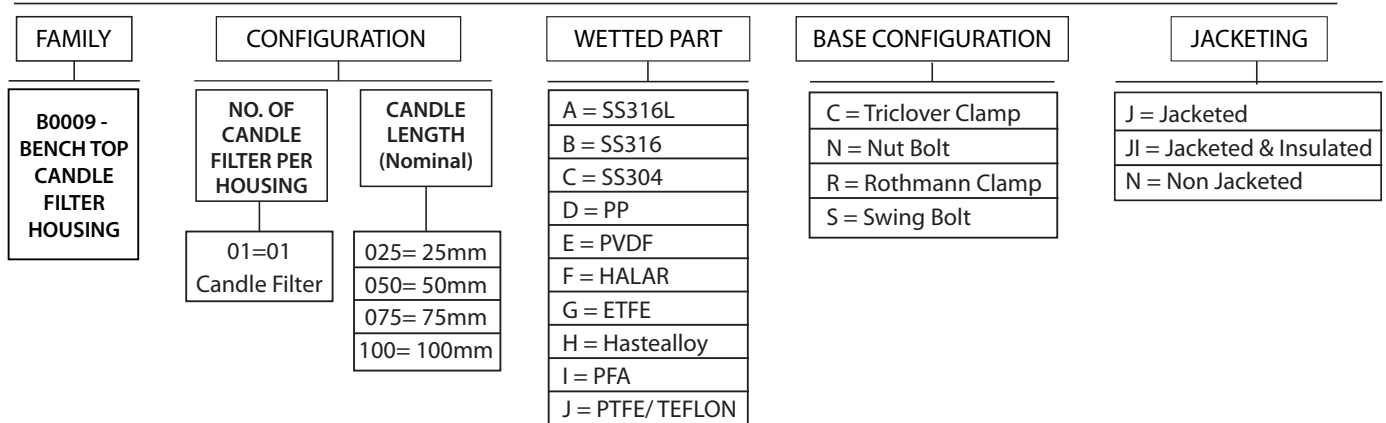

FILTRATION TECHNOLOGY

DEPTH FILTRATION

- Allows particles to penetrate the filter matrix
- Work by both direct interception of particles and absorption
- Broad pore size distribution
- Large holding capacities and initially have a higher resistance to flow.

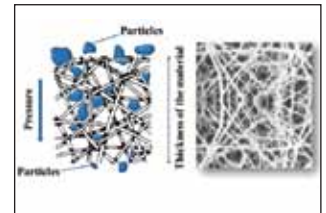

ADSORPTIVE FILTRATION

- Adsorption is the adhesion of atoms, ions, or molecules from a gas, liquid, or dissolved solid to a surface.
- Most of colloids carries charge on the surface, filtration combined with adsorption are very effective in such filtration challenges.

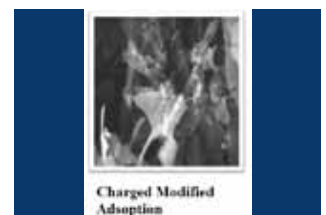

SURFACE FILTRATION

- Only hold particles above filter matrix
- Dirt is trapped on the upstream side of the media .
- Holding capacity depends on filter media construction.

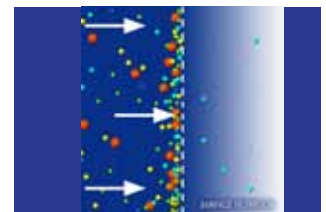

CROSS FLOW FILTRATION

- In cross flow filtration, an incoming feed stream passes across the surface of a cross flow membrane, and two exiting streams are generated.
- The permeate stream is the portion of the fluid that passes through the membrane.
- Ideally suited for Concentration & Purification of many processes.

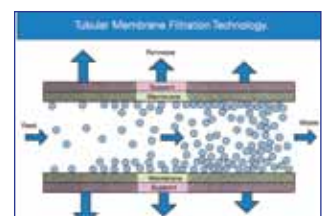

The Filtration Spectrum

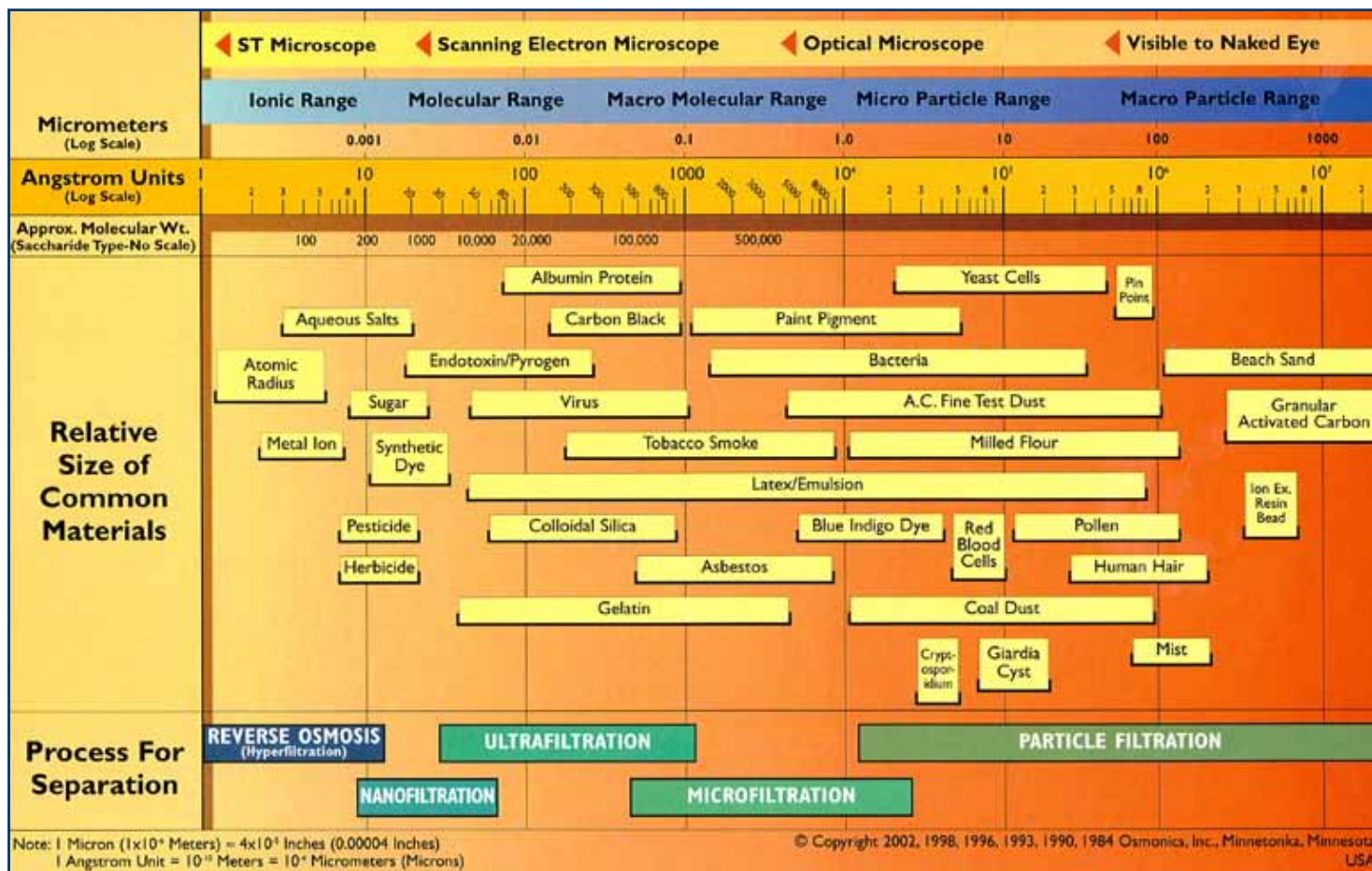

QUALITY

Microfilt offers a wide choice of high quality engineered housings with precise construction for general use & critical applications. At Microfilt, quality is integral part of the entire manufacturing process and not as afterthought. We believe that "Quality in a service or product is not what you put into it. It is what the client or customer gets out of it."

ENGINEERING

Microfilt Application Engineers, with wide exposure to your industry/sector, will help you to select the filtration system/process which is best suited for your requirements. Installation drawings for filter housings are available on request from our Technical Databank.

Once drawings are finalized & materials are chosen, engineering department works on production. During this phase, precision strict quality determines the capability and stability of the manufacturing equipment, as well as the final product.

OUR PRODUCT (viz a viz) TECHNOLOGY PLATFORM

FILTER MEDIA	FILTRATION EQUIPMENTS
DEPTH FILTRATION	
PLEATED FILTER MEDIA PP- MICROPP	Cartridge Housing
DEPTH FILTER MEDIA Wound-MICROPOLY-WD Melt Blown- MICROPOLY-MBD Resin Bonded-MICROREBO-D Thermally bonded- MICROPOLY-TBD	Cartridge Housing
BAG FILTER Non woven- MICROBAG-NW Multifilament- MICROBAG-MU	Bag Filter Housing
METALLIC FILTER Sintered Powder- MICROSINT Sintered Fiber-MICROSINF	Candle Filter System
ADSORPTIVE FILTRATION	
CMDF(CHARGED MODIFIED DEPTH FILTER) CMDF(Cellulose + Filter aid) CMDF (Cellulose + Carbon)	<ul style="list-style-type: none"> • Lenticular System • HPMS (Horizontal Plate Microfilt System) • Plate & frame Filter
SURFACE FILTRATION	
PLEATED FILTER MEDIA PTFE- MICROFLURO PVDF-MICROPVDF NYLON-MICROLON PES-MICROPES	Cartridge Housing
BAG FILTER Monofilament- MICROBAG-MO Woven- MICROBAG-W	Bag Filter Housing
METALLIC FILTER MEDIA Wedge wire-MICROSLOT Wire Mesh-MICROWIRE Strainer-MICROSTRAIN	MAS (Microfilt automated strainer)
CROSS FLOW FILTRATION	
CROSS FLOW FILTER Ceramic Membrane Spiral Membrane Hollow Fiber Cassette	Cross Flow Filtration System

www.microfiltindia.com



Microfilt India Pvt. Ltd.
 247/2, GIDC Phase II,
 Umbergaon-396171
 Dist. Valsad, Gujarat
 Ph: +91 260 2561392
marketing@microfiltindia.com

Microfilt Filter Media Pvt. Ltd.
 PAP-A-222 TO A-227
 TTC Industrial Area
 Mhape, Navi Mumbai- 400 701
 Phone: +91 22 27781499
salesmfpl@microfiltindia.com

Microfilt Filtration Centre Pvt. Ltd.
 F-56, Krishna Signature Mall,
 Opp. Kalpataru Society, Station Road,
 Umbergaon, Gujarat – 396165.
 Phone: +91 260 2563532
mfc@micromfc.com